

Microscope V4.04

(Version 4.01 avec tube acrylique noir \varnothing 3/4" x 1/2" et joint torique 202)

 Commission scolaire des PREMIÈRES-SEIGNEURIES csdps.qc.ca	
Dessinateur Jean-François Garneau, ing.	
Microscope V4.04	
Format A	
2014-05-21 Date	Page 1 de 6
mm Unité	

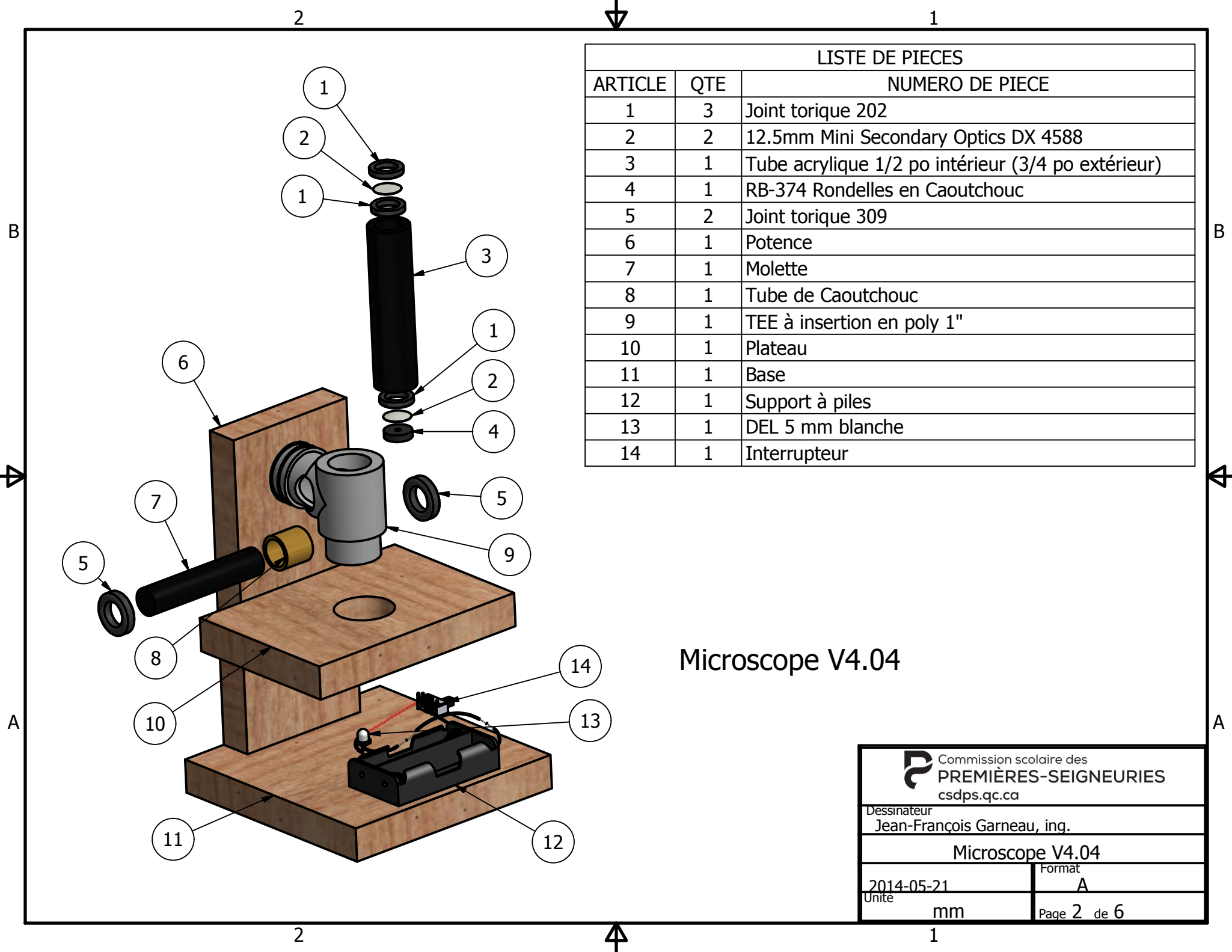

LISTE DE PIÈCES		
ARTICLE	QTE	NUMERO DE PIÈCE
1	3	Joint torique 202
2	2	12.5mm Mini Secondary Optics DX 4588
3	1	Tube acrylique 1/2 po intérieur (3/4 po extérieur)
4	1	RB-374 Rondelles en Caoutchouc
5	2	Joint torique 309
6	1	Potence
7	1	Molette
8	1	Tube de Caoutchouc
9	1	TEE à insertion en poly 1"
10	1	Plateau
11	1	Base
12	1	Support à piles
13	1	DEL 5 mm blanche
14	1	Interrupteur

Microscope V4.04

 Commission scolaire des PREMIÈRES-SEIGNEURIES csdps.qc.ca	
Dessinateur Jean-François Garneau, ing.	
Microscope V4.04	
2014-05-21 Date	Format A
mm Unité	Page 2 de 6

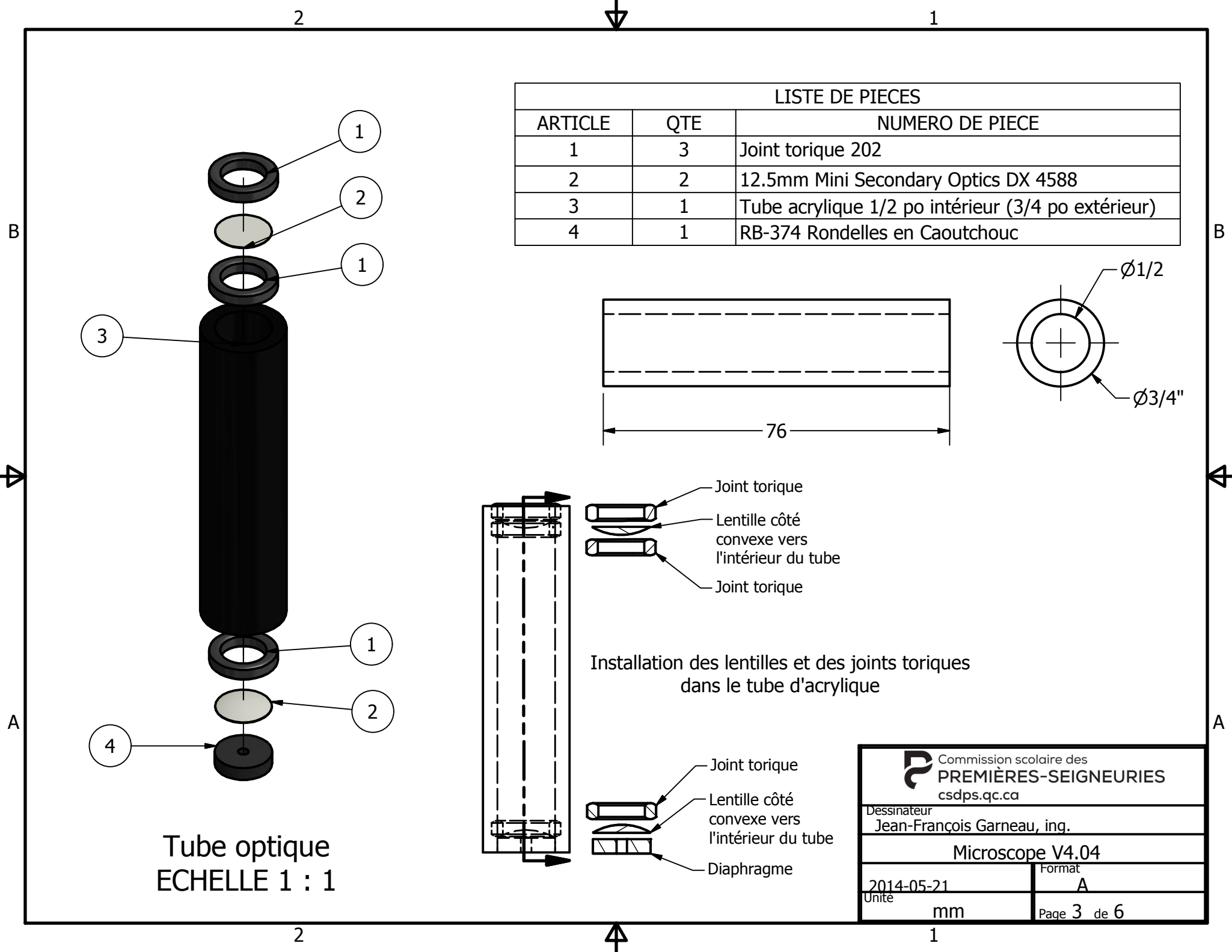

LISTE DE PIECES		
ARTICLE	QTE	NUMERO DE PIECE
1	3	Joint torique 202
2	2	12.5mm Mini Secondary Optics DX 4588
3	1	Tube acrylique 1/2 po intérieur (3/4 po extérieur)
4	1	RB-374 Rondelles en Caoutchouc

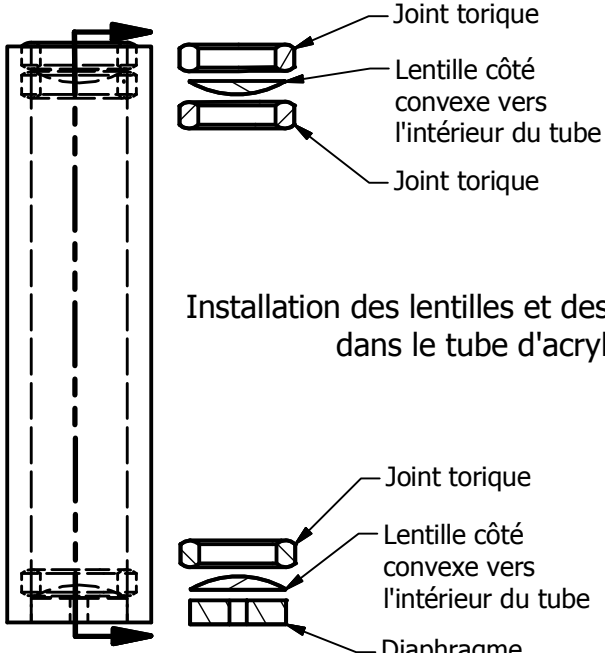
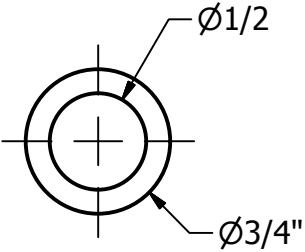
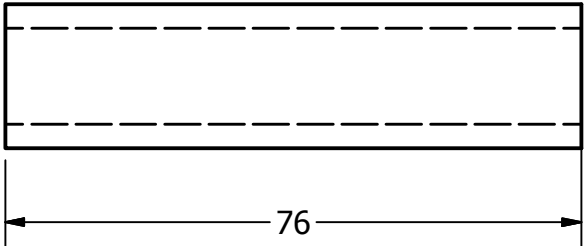

Installation des lentilles et des joints toriques dans le tube d'acrylique

Tube optique
ECHELLE 1 : 1

 Commission scolaire des PREMIÈRES-SEIGNEURIES csdps.qc.ca	
Dessinateur Jean-François Garneau, ing.	
Microscope V4.04	
2014-05-21 Date	Format A
mm Unité	Page 3 de 6

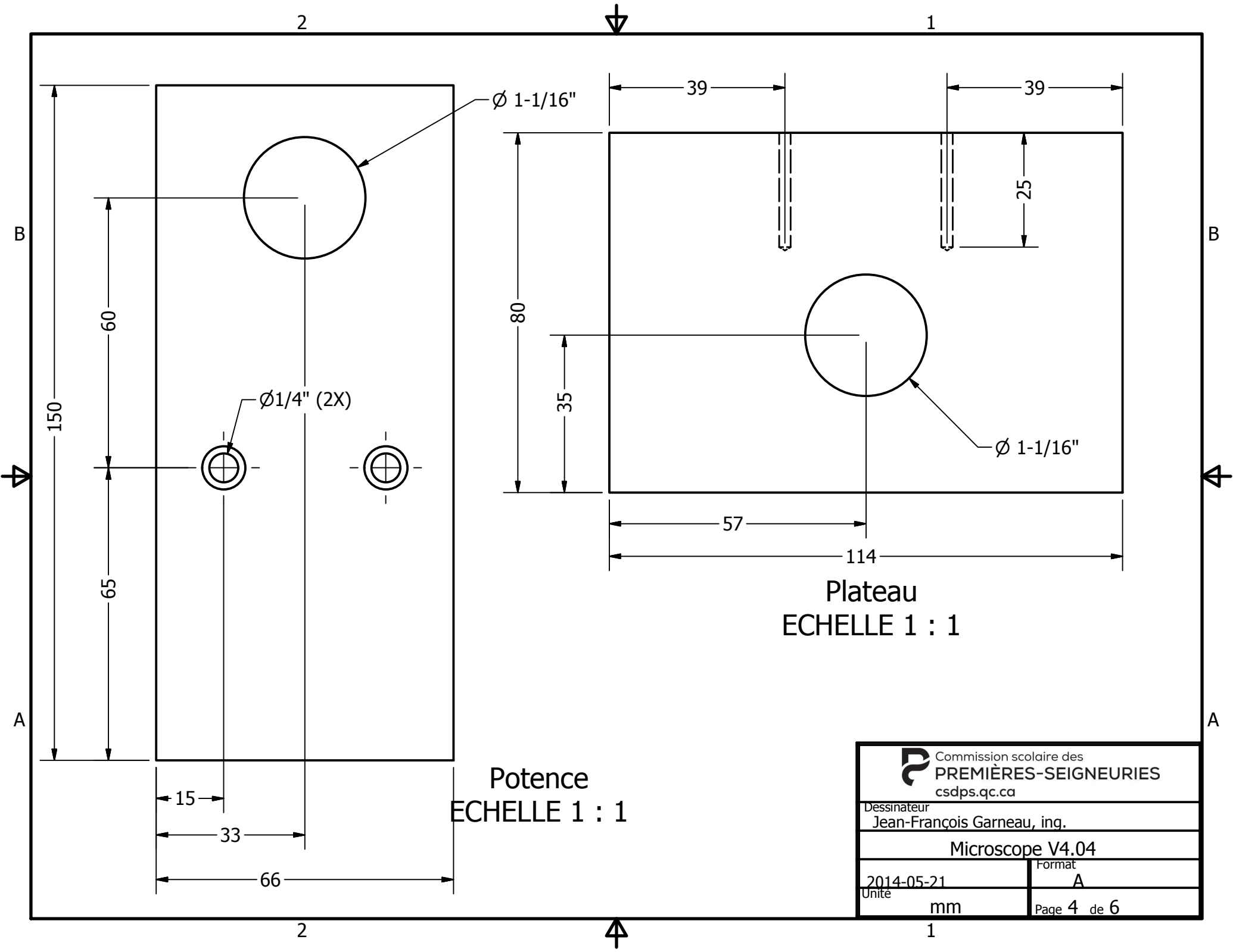

Potence
ECHELLE 1 : 1

Plateau
ECHELLE 1 : 1

 Commission scolaire des PREMIÈRES-SEIGNEURIES csdps.qc.ca	
Dessinateur Jean-François Garneau, ing.	
Microscope V4.04	
2014-05-21 Unité	Format A
mm	Page 4 de 6

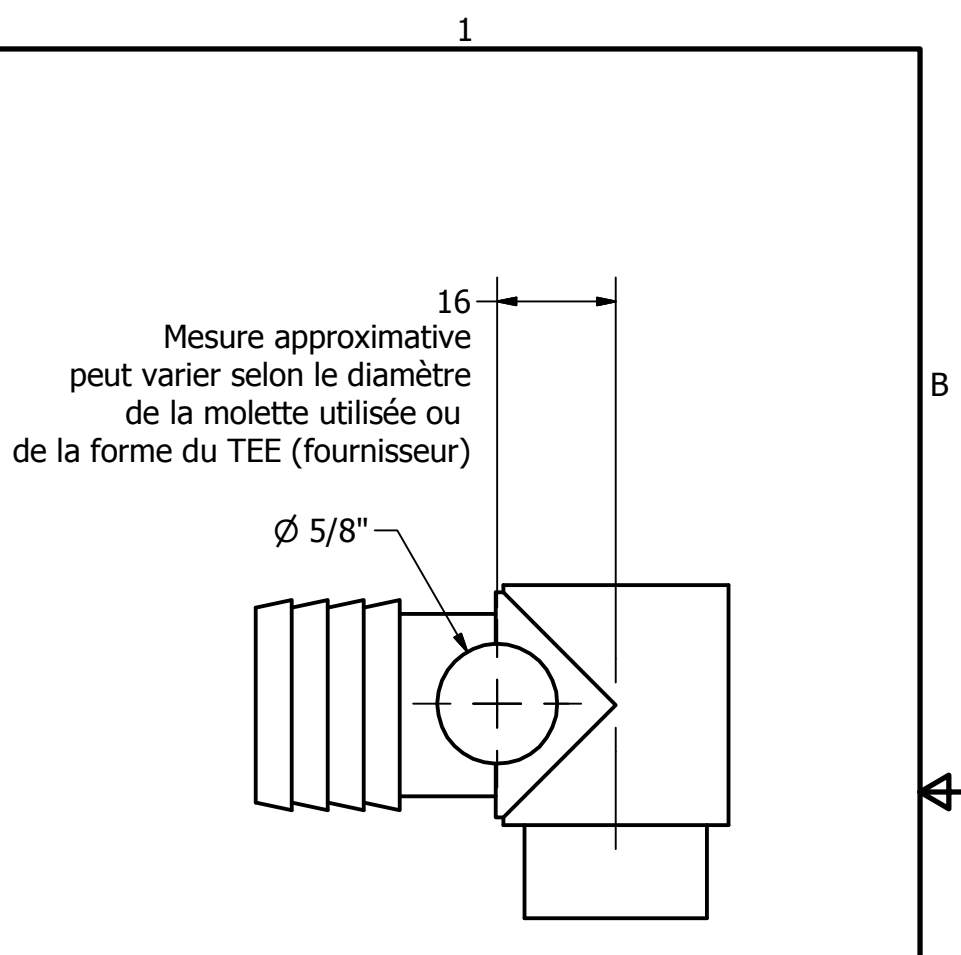
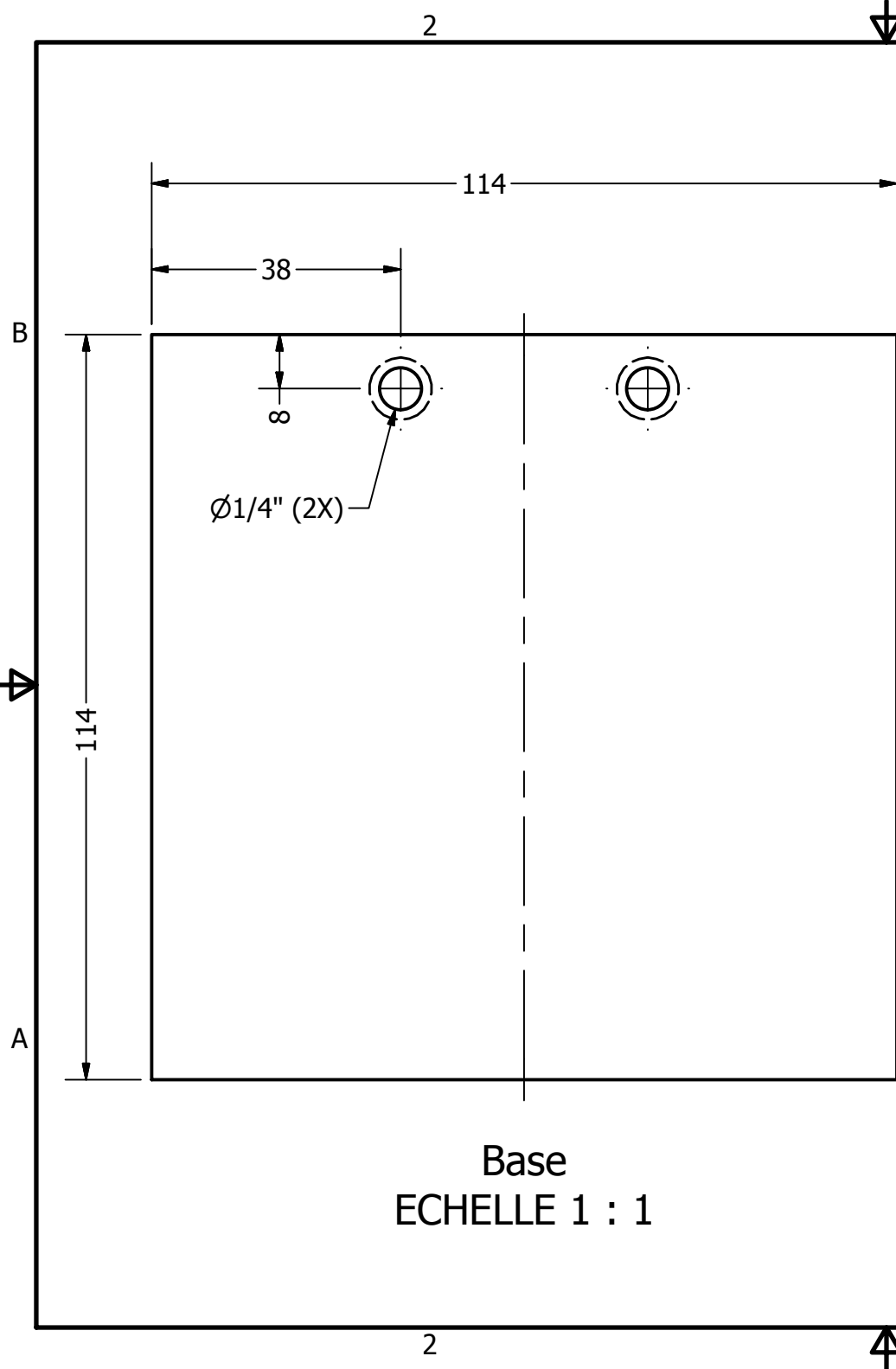

TEE à insertion en poly 1''
ECHELLE 1 : 1

 Commission scolaire des PREMIÈRES-SEIGNEURIES csdps.qc.ca	
Dessinateur Jean-François Garneau, ing.	
Microscope V4.04	
2014-05-21 Date	A Format
mm Unité	Page 5 de 6

2

1

B

B

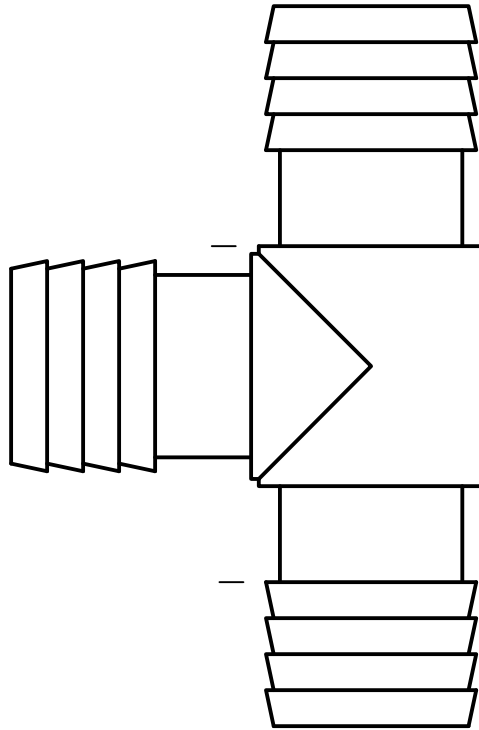

Localisation des coupes qui devront être effectuées.

A

A

TEE à insertion en poly 1"
 ECHELLE 1 : 1

2

1

 Commission scolaire des PREMIÈRES-SEIGNEURIES csdps.qc.ca	
Dessinateur Jean-François Garneau, ing.	
Microscope V4.04	
2014-05-21 Date	A Format
mm Unité	Page 6 de 6